

YAMAHA

TX802

FM TONE GENERATOR

OWNER'S MANUAL

IMPORTANT SAFETY AND INSTALLATION INSTRUCTIONS

INFORMATION RELATING TO POSSIBLE PERSONAL INJURY, ELECTRIC SHOCK, AND FIRE HAZARD POSSIBILITIES HAS BEEN INCLUDED IN THIS LIST.

WARNING—When using electronic products, basic precautions should always be followed, including the following:

1. Read all Safety and Installation Instructions, Supplemental Marking and Special Message Section data, and any applicable assembly instructions BEFORE using this product.
2. Check unit weight specifications BEFORE you attempt to move this product.
3. Main power supply verification. Yamaha Digital Musical Instrument products are manufactured specifically for use with the main supply voltage used in the area where they are to be sold. The main supply voltage required by these products is printed on the name plate. If any doubt exists please contact the nearest Yamaha Digital Musical Instrument retailer.
4. Some Yamaha Digital Musical Instrument products utilize external power supplies or adapters. Do NOT connect products of this type to any power supply or adapter other than the type described in the owners manual or as marked on the unit.
5. This product may be equipped with a plug having three prongs or a polarized line plug (one blade wider than the other). If you are unable to insert the plug into the outlet, contact an electrician to have the obsolete outlet replaced. Do NOT defeat the safety purpose of the plug. Yamaha products not having three prong or polarized line plugs incorporate construction methods and designs that do not require line plug polarization.
6. WARNING—Do NOT place objects on the power cord or place the unit in a position where any one could walk on, trip over, or roll anything over cords of any kind. An improper installation of this type can create the possibility of a fire hazard and/or personal injury.
7. Environment: Your Yamaha Digital Musical Instrument should be installed away from heat sources such as heat registers and/or other products that produce heat.
8. Ventilation: This product should be installed or positioned in a way that its placement or location does not interfere with proper ventilation.
9. Yamaha Digital Musical Instrument products are frequently incorporated into "Systems" which are assembled on carts, stands, or in racks. Utilize only those carts, stands, or racks that have been designed for this purpose and observe all safety precautions supplied with the products. Pay special attention to cautions that relate to proper assembly, heavier units being mounted at the lower levels, load limits, moving instructions, maximum usable height and ventilation.
10. Yamaha Digital Musical Instrument products, either alone or in combination with amplification, headphones, or speakers, may be capable of producing sound levels that could cause permanent hearing loss. Do NOT operate at high volume levels or at a level that is uncomfortable. If you experience any discomfort, ringing in the ears, or suspect any hearing loss, you should consult an audiologist.
11. Do NOT use this product near water or in wet environments. For example, near a swimming pool, spa, in the rain, or in a wet basement.
12. Care should be taken so that objects do not fall, and liquids are not spilled into the enclosure.
13. Yamaha Digital Musical Instrument products should be serviced by a qualified service person when:
 - a. The power supply/power adapter cord or plug has been damaged; or
 - b. Objects have fallen, or liquid has been spilled into the product; or
 - c. The unit has been exposed to rain; or
 - d. The product does not operate, exhibits a marked change in performance; or
 - e. The product has been dropped, or the enclosure of the product has been damaged.
14. When not in use, always turn your Yamaha Digital Musical Instrument equipment "OFF". The power supply cord should be unplugged from the outlet when the equipment is to be left unused for a long period of time. NOTE: In this case, some units may lose some user programmed data. Factory programmed memories will not be affected.
15. Electromagnetic Interference (RFI). Yamaha Digital Musical Instruments utilize digital (high frequency pulse) technology that may adversely affect Radio/TV reception. Please read FCC Information (next page) for additional information.
16. Do NOT attempt to service this product beyond that described in the user maintenance section of the owners manual. All other servicing should be referred to qualified service personnel.

**PLEASE KEEP THIS MANUAL
FOR FUTURE REFERENCE!**

SUPPLEMENTAL MARKING INFORMATION SPECIAL MESSAGE SECTION

Yamaha Digital Musical Instrument Products will have either a label similar to the graphic shown below or a molded /stamped facsimile of the graphic on its enclosure. The explanation of these graphics appears on this page. Please observe all cautions indicated.

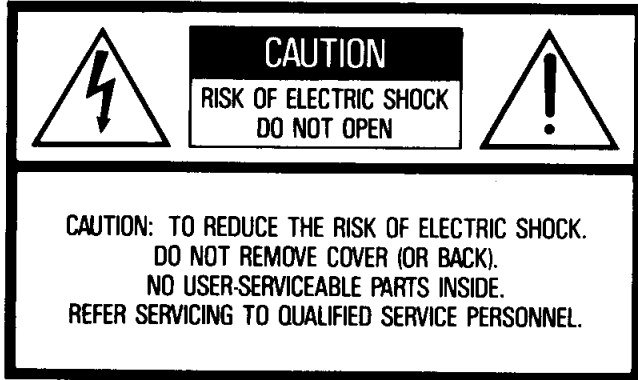

The exclamation point within an equilateral triangle is intended to alert the user to the presence of important operating and maintenance (servicing) instructions in the literature accompanying the product.

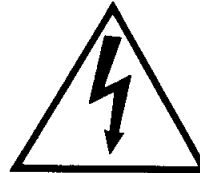

The lightning flash with arrowhead symbol, within an equilateral triangle, is intended to alert the user to the presence of uninsulated "dangerous voltage" within the product's enclosure that may be of sufficient magnitude to constitute a risk of electric shock to persons.

ELECTROMAGNETIC INTERFERENCE (RFI): Your Yamaha Digital Musical Instrument Product has been type tested and found to comply with all applicable regulations. However, if it is installed in the immediate proximity of other electronic devices, some form of interference may occur. For additional RFI information see FCC Information section located in this manual.

IMPORTANT NOTICE: This product has been tested and approved by independent safety testing laboratories in order that you may be sure that when it is properly installed and used in its normal and customary manner, all foreseeable risks have been eliminated. DO NOT modify this unit or commission others to do so unless specifically authorized by Yamaha. Product performance and/or safety standards may be diminished. Claims filed under the expressed warranty may be denied if the unit is / has been modified. Implied warranties may also be affected.

SPECIFICATIONS SUBJECT TO CHANGE: The information contained in this manual is believed to be correct at the time of printing. Yamaha reserves the right to change or modify specifications at any time without notice or obligation to update existing units.

NOTICE: Service charges incurred due to a lack of knowledge relating to how a function or effect works (when the unit is operating as designed), are not covered by the manufacturer's warranty. Please study this manual carefully before requesting service.

STATIC ELECTRICITY CAUTION: Some Yamaha Digital Musical Instrument products have modules that plug into the unit to perform various functions. The contents of a plug-in module can be altered/damaged by static electricity discharges. Static electricity build-ups are more likely to occur during cold winter months (or in areas with very dry climates) when the natural humidity is low. To avoid possible damage to the plug-in module, touch any metal object (a metal desk lamp, a door knob, etc.) before handling the module. If static electricity is a problem in your area, you may want to have your carpet treated with a substance that reduces static electricity build-up. See your local carpet retailer for professional advice that relates to your specific situation.

Model _____

Serial No. _____

Purchase Date _____

This information on safety is provided to comply with U.S.A. laws, but should be observed by users in all countries.

INTRODUCTION

Thank you for purchasing the Yamaha TX802 FM Tone Generator. The TX802 contains 8 independent tone generators in a compact two-space rack-mountable case, and can produce up to 16-note polyphony. It uses the same sound-producing circuitry as the DX7II synthesizer and can use voice data created for the popular DX7 synthesizer.

The sheet of Quick Playing Instructions included with the TX802 will tell you how to try out the Performance and Voice memories. When you are ready to learn more, read through this manual page by page.

This manual assumes you know something about MIDI, the world-wide standard interface for digital musical instruments. Supplementary material explaining MIDI is available from Yamaha.

CONTENTS

FEATURES	3
PRECAUTIONS	3
FRONT/REAR PANEL	4
PERFORMANCE SELECT	6
VOICE SELECT	7
SYSTEM SETUP	8
UTILITY MODE	11
PERFORMANCE EDIT	14
VOICE EDIT (I)	18
VOICE EDIT (II)	22
WHAT'S FM?	24
SPECIFICATIONS	26
BANK A/B VOICE LIST	27
MICRO TUNING DATA TABLE	28
PERFORMANCE MEMO CHART	29
VOICE MEMO CHART	30
MIDI IMPLEMENTATION CHART	31
MIDI RECEPTION	32
MIDI TRANSMISSION	33
MEMORY STRUCTURE	34
INDEX	36

FEATURES

- * Eight independent tone generators, each with an individual audio output.
- * Tone generators can be linked together to play chords of up to 16 notes.
- * Voice data and all memory parameters can be edited from the front panel. No separate programming device or computer is necessary.
- * Each of the 8 tone generators uses the same LSI as the DX7II synthesizer, producing especially clear and powerful FM sounds.
- * 128 factory preset voices in ROM.
- * 64 user-programmable voice memories.
- * 64 user-programmable performance memories.
- * Microtonal Scales.
- * Fractional Scaling for precise voicing.
- * Controller Assign Table allows incoming MIDI Control messages to be reassigned.
- * Cartridge interface for quick external data storage. (ROM and RAM cartridges are not included.)
- * Large 40-character two-line illuminated LCD.
- * Front panel ten-key pad for speedy memory selection and data entry.
- * Handy tilt stand is attached underneath for a convenient operating angle when the unit is placed on a table.

PRECAUTIONS

- * Avoid placing the unit in direct sunlight or close to a source of heat. Also, avoid locations where the unit is likely to be subjected to vibration, excessive dust, cold or moisture.
- * Avoid applying excessive force to the switches, dropping or rough handling. While the internal circuitry is of reliable integrated circuit design, the unit should be treated with care.
- * Always grip the plug directly when removing it from an AC receptacle. Removing the plug from the AC receptacle by pulling the cord can result in damage to the cord and possibly a short circuit. It is also a good idea to disconnect the unit from the AC receptacle if you don't plan to use it for an extended period of time.
- * If necessary, clean the unit using a slightly damp cloth, and dry with a soft cloth. Never use solvents (such as benzine or thinner) since they can melt or discolor the finish.
- * All computer circuitry, including that in this unit, is sensitive to voltage spikes. For this reason, the unit should be turned off and unplugged from the AC receptacle in the event of an electrical storm. This precaution will avoid the chance that a high voltage spike caused by lightning will damage the unit.
- * Computer circuitry is also sensitive to electromagnetic radiation. Be careful not to set it too close to equipment (such as a television set) that generates electromagnetic fields. Proximity to such equipment could cause malfunctions in the TX802's digital circuitry and interfere with the operation of the other unit.
- * When inserting a cartridge in the cartridge slot, make sure it is facing the correct way, and do not use excessive force.
- * This unit contains no user servicable parts. Opening it or tampering with it can lead to electrical shock as well as damage, and will void the product warranty. Refer all servicing to qualified Yamaha personnel.

FRONT/REAR PANEL

FRONT PANEL

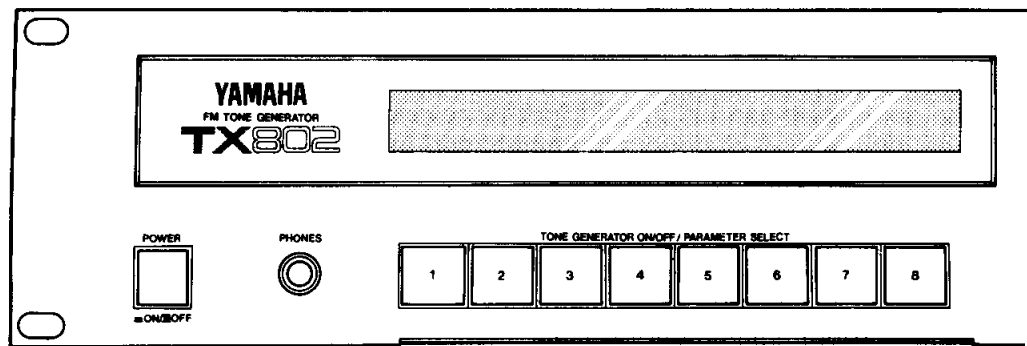

PHONES

A jack for standard stereo headphones. It carries the same output as the rear panel outputs I and II. Using this jack will not affect the rear panel outputs. The volume is controlled by the Performance Volume for each voice.

LCD

A two-line 40-character Liquid Crystal Display, illuminated for high visibility.

OPERATION GUIDE

Two pull-out cards; an operational guide and a reference card for FM synthesis.

TONE GENERATOR ON/OFF / PARAMETER SELECT

In PERFORMANCE SELECT and VOICE SELECT modes these turn each tone generator on or off. The LEDs will blink when a tone generator receives a MIDI Note On message.

In other modes these select parameters from the menu displayed in the LCD.

PERFORM SELECT

In PERFORM SELECT mode you can select performances 1-64 from internal or cartridge memory.

VOICE SELECT

In VOICE SELECT mode you can specify the voices to be used in a performance, or turn off a voice to form polyphonic instruments. (Linked tone generators.)

SYSTEM SETUP

In SYSTEM SETUP mode you can make various settings of the TX802 itself, and specify how it will be controlled via MIDI. You can also edit Micro Tuning scales.

UTILITY

In UTILITY mode you can perform various functions such as transmitting, saving and loading data via MIDI or to a cartridge.

PERFORM EDIT

In PERFORM EDIT mode you can set up a combination of up to 8 instruments and specify the MIDI channel, volume, output, note limit etc. for each one.

VOICE EDIT (I)

Here are the parameters that determine how the voice sounds, ie. the FM synthesis parameters.

VOICE EDIT (II)

Here are the parameters that determine how the voice is controlled via MIDI, i.e. controller settings.

STORE/COMPARE

In PERFORM SELECT or VOICE SELECT modes, this switch lets you store Performances or Voices to internal or cartridge memory.

In VOICE EDIT or PERFORMANCE EDIT modes, this switch lets you compare the edited data with the original data.

CARTRIDGE SLOT

This accepts a Yamaha RAM4 data cartridge for external data storage. Data cartridges for the original DX7 can also be read (not written to) using an ADP1 cartridge adaptor.

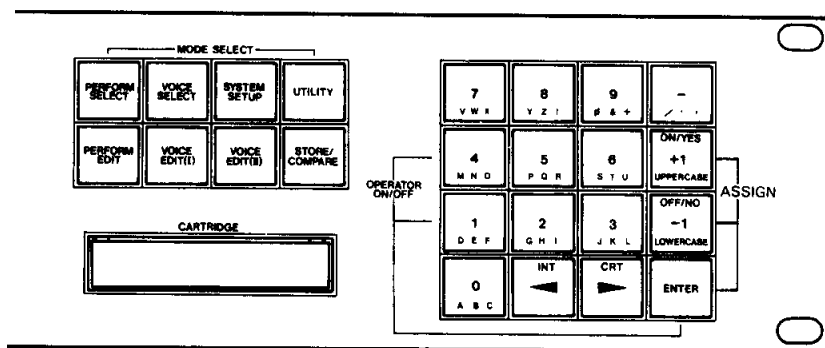

TEN-KEY PAD

A ten-key pad for quick entry of numerical data, or for selecting memories. After entering the desired number, you need to press ENTER.

When editing Performance Name or Voice Name, these are used to input alphanumeric characters. In VOICE EDIT (II) mode, you can hold ENTER and use keys 1-6 to turn operators on or off.

+1 YES /-1 NO

These are used to enter "on/off" or "multiple-choice" data, to select memories one by one, or to answer prompts that appear in the LCD.

When editing Performance Name or Voice Name, these are used to switch between uppercase and lowercase letters.

INT / CRT (CURSOR)

In PERFORMANCE SELECT mode or STORE mode, these keys select Internal or Cartridge memory.

In other modes they move the cursor "◀". To move the special cursor "◀◀", use the cursor keys while holding ENTER.

ENTER

This is used to enter the number typed in with the ten-key pad. In some modes, holding down ENTER will change the function of the +1/-1 and INT/CRT keys.

REAR PANEL

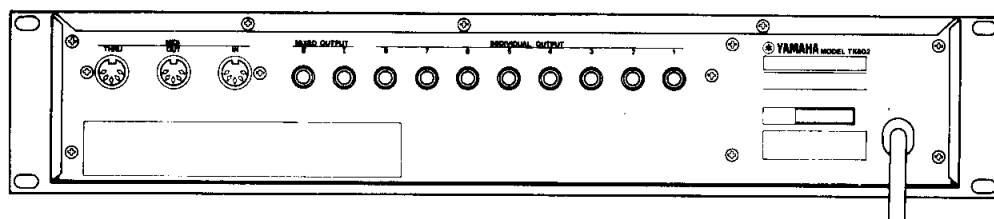

MIDI THRU

All messages received at MIDI IN are re-transmitted unchanged from this terminal.

MIDI OUT

TX802 bulk data can be sent from this terminal.

MIDI IN

MIDI messages to control the TX802 are received here, and TX802 bulk data is also received here.

OUTPUT I, II

Each instrument is assignable to either or both of these outputs.

INDIVIDUAL OUTPUTS 1-8

The sound from each tone generator is always sent from these outputs.

PERFORMANCE SELECT

You will normally play the TX802 in this mode. The TX802 contains 8 tone generators, each with its own rear panel audio output. Each tone generator can be set to a different voice and MIDI channel, and played as an independent instrument with up to 2 simultaneous notes. Or several tone generators can be linked together to form an instrument with 4-16 note polyphony.

A combination of settings for these 8 tone generators is called a Performance. There are 64 performance memories inside the TX802, and you can store another 64 in a cartridge.

The Performance Number and Name are displayed in the upper line of the LCD. The lower line shows the voice numbers used. Long arrows "←" to the right of a voice number means that tone generators have been Linked (p.7) to form an instrument of 4-16 note polyphony. Short arrows "←" between voice numbers indicate that these voices are Alternately Assigned (p.15), and successive notes will alternately play each voice.

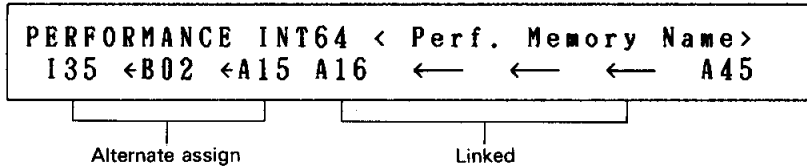

A separately included booklet lists the 64 performance memories that were in the TX802 when shipped.

Tone Generator On/Off

By pressing TONE GENERATOR ON/OFF 1-8 you can "turn off" the MIDI input to a tone generator. Tone generators that are linked or in alternate assign mode (p.7, 15) will turn on or off together.

Store Performance

You can store the current performance memory (edited or not) into an internal or cartridge memory. Internal (p.10) or cartridge memory protect (on the cartridge itself) must be off. In PERFORMANCE SELECT mode, press STORE. The LCD will ask "STORE . . . to INT01?" or whatever the original memory was. Use INT/CRT to specify internal or cartridge memory, use the ten-key pad to select the memory number, and then press ENTER. (Only the "?" will blink.) Press YES, and if you are sure, press YES again.

VOICE SELECT

This is where you select voices to use in a Performance memory. The TX802 has 3 banks, each with 64 voice memories; banks A and B are ROM preset voices and bank I is for voices you create or edit. A cartridge (bank C) can contain an additional 64 voice memories. As you move the cursor, the upper line of the LCD will show the name of each voice in the Performance.

If the voice was created using Micro Tuning (p.16) or Fractional Scaling (p.20), a "t" or "f" will be displayed to the left of the voice name. If a cartridge Micro Tuning was used but a Micro Tuning data cartridge is not inserted, the "t" will blink, and Equal Temperament will be used instead. If a Fractional Scaling data cartridge is not inserted, the "f" will blink.

The "Rch" indicates the MIDI channel that this voice is receiving. (Specified for each tone generator in Performance Edit.)

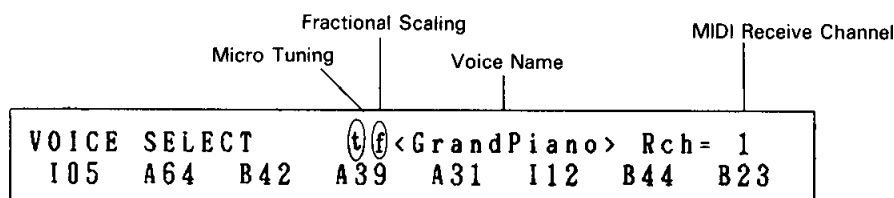

Select Voices

Press +/-1 to select a voice where the cursor is blinking. Or you can use the ten-key pad to enter a number 1-64 and then press ENTER. To select voice memory banks (Internal, Cartridge, A, B) hold ENTER and press INT/CRT. A list of the factory preset voices (banks A and B) is given on p.27.

Linked Tone Generators

Tone generators can be linked together to form an instrument that can play 4-16 simultaneous notes. Pressing ENTER + OFF will switch a voice off. A long arrow "←" will be shown in place of the voice number, and the tone generator to the left will be given two extra notes. In this way, you can use a single instrument to play chords of up to 16 notes. For example in the LCD below, the TX802 is acting as 3 separate instruments; with 8-note, 6-note and 2-note polyphony. To switch the voice on again, press ENTER + ON.

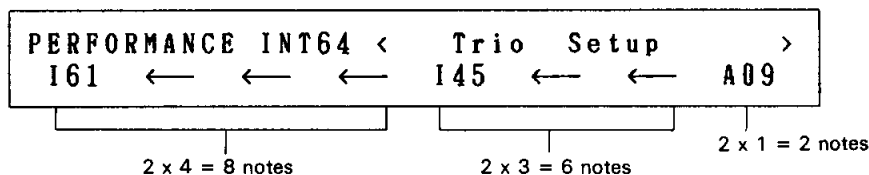

Tone Generator On/Off

Just as in PERFORMANCE SELECT mode, you can "turn off" the MIDI input to a tone generator by pressing TONE GENERATOR ON/OFF 1-8. Tone generators that are linked or in alternate assign mode (p.15) will turn on or off together.

Store Voice

While in VOICE SELECT mode, you can store the currently selected voice to an internal or cartridge memory. Press STORE and use the ten-keys and INT/CRT to specify the destination INT 1-64 or CRT 1-64. Press ENTER, then YES. If you are sure, press YES again. (If the voice uses Fractional Scaling, an appropriately formatted cartridge must be inserted. When you store the voice to INT memory, the Fractional Scaling data will be stored to the corresponding location in the cartridge.)

SYSTEM SETUP

This is where you make various settings for the TX802 itself. When you press SYSTEM SETUP you will get the following display. Press the PARAMETER SELECT keys 1-8 to select parameters.

```

*****  SYSTEM SETUP MENU  *****
midi ctrl pfrm syex bank mted mtun prtct
  1       2       3       4       5       6       7       8
    
```

1. **MIDI Receive**

You can specify how 5 types of incoming MIDI messages will be received. Press SYSTEM 1 to cycle through the choices; Control change, Program Change, After touch, Pitch Bend or Note on/off.

Control change Program change After touch Pitch Bend	off norm G1-G16	Reception of these four messages can be set independently. Messages will not be received. Messages will be received by each instrument on its own channel as specified in PERFORMANCE EDIT 1 "Receive Channel" (p.15). Messages received on the specified "global" channel will affect all instruments in a performance. The settings you made for each instrument in PERFORMANCE EDIT 1 (p.15) will still be effective.
Note on/off	all odd even	All notes will be received (the "normal" mode). Only odd-numbered notes will be received. Only even-numbered notes will be received.

By using two TX802s together and setting one to "odd" and the other to "even", you can double the effective note-producing capability and have up to 32 notes sounding simultaneously (nice for piano sounds). Or you could pan the outputs of each TX802 to left and right, and have odd and even notes come from left and right speakers.

2. **Control Number Assign**

By setting this Control Number Table, you can re-assign incoming MIDI Control Change Messages (Bn.xx.yy). When the blinking cursor is at the left, use the +1/-1 keys (or the ten-keys and press ENTER) to select the incoming control number 0-31 and 64-121. Then move the cursor to the right and select the function that the incoming message will have; off, Mod. Wheel, Breath Control, Foot Control, Portamento Time, Volume, Sustain Switch or Portamento Switch. For example if set to "1:Mod. wheel → Volume", incoming Modulation Wheel messages will control the Volume.

3. Performance Select

This is where you determine how Performance Memories will be selected by incoming Program Change messages. Press SYSTEM 3 to cycle through the three sub-jobs.

Performance Select Channel by program change (off, 1-16, all)

Incoming Program Change messages on the specified channel will select TX802 Performance Memories, and will not affect individual instruments.

Performance Select Assign Table (on/off)

When this is on, Program Changes will select the corresponding Performance Number in the Assign Table (see below). When this is off, Program Change 1 will select Internal Performance 1, 2:INT 2, 3:INT 3 . . . 128:CRT 64.

Performance Select Number Assign (1-128)

This table determines which Performance memory will be selected by each incoming Program Change message. When the cursor is blinking at the program #, use the +1/-1 keys (or the ten-key pad and press ENTER) to select the incoming Program Change number 1-128. Then move the cursor to the right (ENTER + cursor keys) and set the Performance Memory that will be selected. Use INT/CRT to select internal or cartridge performances.

4. System Exclusive

This determines how the TX802 will receive and transmit Bulk Data (voice and performance data, etc.). Press SYSTEM 4 to select the two subjobs.

System Exclusive Device Number (off, 1-16, all)

Bulk Data that arrives on the specified channel will be received. This also sets the bulk data Transmit channel (p.11).

Voice Data Receive Block (1-32, 33-64)

Bulk Voice data is received in blocks of 32 voices. Here you can specify where the incoming 32 Voice Bulk data will be received.

5. Cartridge Bank Select

The RAM 4 data cartridge has only a single bank. However future data cartridges may have up to 16 banks, each of which can contain a different type of data. Thus, a single cartridge could contain TX802 data (64 voice + 64 performance), Fractional Scaling data, and Micro Tuning data, each in a different bank. When a Cartridge Performance is selected, when a voice uses Fractional Scaling, or when a Performance uses a Cartridge Micro Tune memory, the TX802 will look for the data in the cartridge bank you specify (1-16).

6. Micro Tuning Edit

Here you can edit a Micro Tone scale. You can specify the pitch that will be produced for each note (C-2 to G8). Use the +1/-1 keys to raise or lower the pitch for each note. You can move in steps of a semi-tone (Coarse) or steps of 1.1719 cents (Fine). Select Coarse/Fine using ENTER + the cursor keys. The resulting pitch is shown as a note number +42/-43 and also as an absolute number 0-10794. (One octave is 1024 steps.)

To store the Micro Tune scale you have edited, press STORE. Use the ten-key pad and INT/CRT to select the destination (INT 1-2 or CRT 1-63) and press ENTER. Press YES, and if you are sure, press YES again.

**7. *Master
Tuning***

This is the master tuning for the entire TX802. The range is +63 to -64 covering about a half-step up and down. At zero, A3 is 440Hz.

**8. *Internal
Memory
Protect***

To store data into the TX802 or to receive bulk data via MIDI, Memory Protect must be off. When power is turned on. Memory Protect will be on.

UTILITY MODE

Here are the functions dealing with cartridge data, initializing edit buffers and tables. When you press UTILITY you will get the following display. Press the PARAMETER SELECT keys 1-8 to select jobs.

*****								UTILITY MENU								*****							
trns		save		load		frmt		iedb		itbl		rcll		copy									
1	2	3	4	5	6	7	8	1	2	3	4	5	6	7	8	1	2	3	4	5	6	7	8

1. *Transmit*

You can transmit the following types of data from MIDI OUT to be received by another TX802 or a data storage device such as the MDF1. Press the PARAMETER SELECT 1 switch to step through the choices.

- (1) Voice Edit Buffer
The current voice data (edited or not) of the voice indicated by the cursor in Voice Select Mode.
- (2) 1-32 Voice Data
Internal voices 1-32 (bank I).
- (3) 33-64 Voice Data
Internal voices 33-64 (bank I).
- (4) Performance Edit Buffer
The current performance data (edited or not).
- (5) 1-64 Performance Data
All 64 internal performances.
- (6) System Setup Data
Settings you make in SETUP mode (p.8).
- (7) Micro Tuning Edit Buffer
The current micro tuning scale data (edited or not) of the scale indicated by the cursor in Performance Edit Mode.
- (8) Micro Tuning 1-2 Data
The two internal micro tuning scales (p.16).
- (9) Micro Tuning Cartridge Data
63 Micro Tunings from a cartridge. (A cartridge containing Micro Tuning data must be inserted.)

When you have selected the data you want to transmit, press YES. If you are sure, press Yes again. The LCD will display “**BUSY** Now Transmitting!” while the data is being sent, and then “Completed!”.

2. **Save to Cartridge**

You can save the entire memory of the TX802 to a single RAM4 data cartridge. Insert a RAM4 formatted to "TX802" format (see below) and press YES. You will be asked "Are you sure?" so press YES again. The data will be saved to the cartridge. (The cartridge memory protect switch must be off.)

The following data will be saved into the cartridge.

Performance Memory 1-64
Voice Memory 1-64 (bank I)

System Setup Memory (p.11)
Control Number Assign Table (p.8)
Performance Select Assign Table (p.9)
Micro Tuning Memory (the two internal Micro Tunings p.16)

3. **Load from Cartridge**

Data saved to a cartridge (see above) can be loaded into the TX802 in two ways; with or without system data. Press PARAMETER SELECT 3 to choose the loading method. Insert a cartridge that contains "TX802" data and then press YES. You will be asked "Are you sure?" so press YES again. The data will be loaded into the TX802. (Memory protect (p.10) must be off.)

"With System" ---- All data will be loaded.

"Without System" -- Only Voice and Performance data will be loaded.

Note

Voice data cartridges for the original DX7 can be loaded into the TX802 by inserting the ADP1 Cartridge Adaptor. These cartridges contain 32 voices, and you will be asked which block of TX802 memory you want to load them into. "Load voice 1-32 from cartridge" or "Load voice 33-64 from cartridge."

Voice data cartridges for the new DX7II can also be loaded into the TX802, but only voice data (not performance data) can be loaded.

4. **Format Cartridge**

Before a RAM cartridge can be used to store data, it must be Formatted to accept the type of data you wish to store. When you insert a cartridge, the top line of the LCD will show the type of data it contains, for example "Bank01 (TX802)", or "(unfmt)" for an unformatted cartridge. When using multi-bank cartridges (see note below), use the ten-key pad to specify the bank you wish to format and press ENTER. Press PARAMETER SELECT 4 to select the type of data and press YES. You will be asked "Are you sure?" so press YES again.

TX802 format (TX802)

64 Voice +64 Performance + System Data (see p.11)

Fractional Scaling (FKS-Y)

64 Fractional Scaling data (see p.20)

Micro Tuning (MTT-Y)

63 Micro Tunings (see p.16)

Note

The RAM 4 data cartridge has only a single bank. However, it is possible that future data cartridges will have up to 16 banks, each of which can be independently formatted and can contain different types of data. See also the System Setup parameter Cartridge Bank Select (p.9).

5. *Initialize Edit Buffer*

This lets you initialize either the Performance or Voice edit buffer to the standard settings shown below. Press PARAMETER SELECT 5 to select the Performance or Voice edit buffer and press YES. You will be asked "Are you sure?" so press YES again.

Initialized Voice: The simplest possible voice with "organ-like" envelopes, and Output Level of 99 for operator 1 and Output Level 0 for operators 2-6.

Initialized Performance: A single 16-note polyphonic instrument; receive channel 1, voice number 101, volume 90, low/high limits maximum, and output assign I + II.

6. *Initialize Table*

The Control Number table (p.8) allows you to redefine incoming MIDI control messages. The Performance Select table (p.9) allows you to set which Performance memory is selected by which incoming MIDI Program Change message. This Initialize Table function lets you to initialize either of these tables to its standard setting. Press PARAMETER SELECT 6 to select the Control Number or Program Change table and press YES. You will be asked "Are you sure?" so press YES again.

7. *Recall Edit Buffer*

If while editing you accidentally select a Performance or Voice and wipe out the edited data, you can use this function to recall the data to the edit buffer. Press PARAMETER SELECT 7 to select the Performance or Voice edit buffer and press YES. You will be asked "Are you sure?" so press YES again. The previously edited data will be recalled.

8. *Copy*

When editing voice data (p.18) it is often useful to copy the EG or oscillator settings of one operator to another. You have three ways to copy data. Press PARAMETER SELECT 8 to select the operator data you want to copy.

EG and Scaling

EG parameters, Rate Scaling, Level Scaling parameters.

Oscillator

Oscillator Mode, Frequency, Detune.

Operator

All operator parameters (The above two and Velocity and AMS.)

Select the source and destination by moving the blinking cursor to the operator number, using the ten-key pad to set the operator number and pressing ENTER. When the source and destination are set correctly, press YES. You will be asked "Are you sure?" so press YES again. The data will be copied from operator to operator.

PERFORMANCE EDIT

A performance is a combination of settings for up to eight instruments. Each performance memory contains the following data.

Tone Generators	1	2	3	4	5	6	7	8
Voice number	Banks I, C, A, B 1-64							
Channel	1-16, omni							
Forced Damp	on/off							
Volume	0-99							
Output Assign	off, I, II, I + II							
Low Limit	C-2 - G8							
High Limit	C-2 - G8							
Note Shift	-24 - +24							
Micro Tuning Scale	-P1-11, I1-2, C1-63							
Micro Tuning Key	C-B							
Detune	-7 - +7							
Performance Name	20 characters							

There is a blank Performance Memory chart on p.29 that you may copy for your own settings. When you press PERFORM EDIT you will get the following display. Press the PARAMETER SELECT keys 1-8 to select parameters.

```

***** PERFORMANCE EDIT MENU *****
rcvch vol out lmt shft mtt# dtune name
1      2      3      4      5      6      7      8
    
```

The Performance Edit Buffer

When you select a Performance Memory, the data is loaded into a place called the Performance Edit Buffer, and this data tells the TX802 how to behave. Changes you make in PERFORMANCE EDIT mode affect only this buffer, and are not permanent until Stored into an Internal or Cartridge Performance Memory. (See Store p.6). Once a Performance has been edited, the LCD in PERFORMANCE SELECT mode (p.6) will show "int" or "crt" in lower-case letters, indicating that the performance data has been modified.

Compare

Any time you are editing a performance, you can press COMPARE to see and hear the original performance data. In COMPARE mode, all parameters in the LCD will blink, and you will not be able to modify the data. Look through the parameters just as in normal edit mode. To return to edit mode, press COMPARE again.

Linked Tone Generators

When two or more tone generators have been linked together (p.7) to form an instrument with 4 or more notes, the LCD will show an arrow "←" for that instrument, and its data will not be displayed.

1. *Receive Channel/ Alternate Assign/ Forced Damp*

(1-16, omni)

Messages on this MIDI channel will be received by this instrument. If you set "omni", messages on any channel will be accepted. See also SYSTEM SETUP MIDI Receive (p.8).

Program Change messages on this channel will select voices for this instrument UNLESS this channel has been specified as the Performance Memory Select channel (p.9) or Program Change message reception has been switched off (p.8).

When adjacent instruments are receiving the same MIDI channel, they can be set to Alternate Assign. Press ENTER + ON and a short arrow "←" will appear to the left of the channel number, indicating that the instrument is in Alternate Assign mode. In this mode, each incoming note will rotate between the alternately assigned instruments. If three instruments playing Strings, Brass and Piano were set to Alternate Assign, a three-note chord would include one note of each voice. (However, by switching each instrument in and out of Alternate Assign mode in random order, it is possible to confuse the assignment scheme so that a three-note chord may be sounded as 2, 1, 0 instead of 1, 1, 1.)

Press PARAMETER SELECT 1 again to get the EG Forced Damp display. When you play more simultaneous notes than an instrument can produce, the oldest note will stop sounding in order to "make room" for the new note. When EG Forced Damp is off, the envelope of the new note will be a continuation of the note that has stopped sounding. When EG Forced Damp is on, the envelope of the old note will quickly drop to 0, and the new note will start its envelope from the beginning.

EG Forced damping off

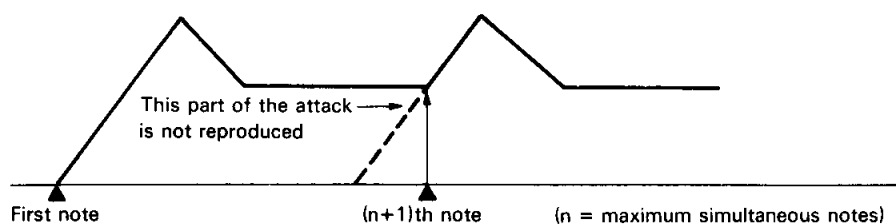

EG Forced damping on

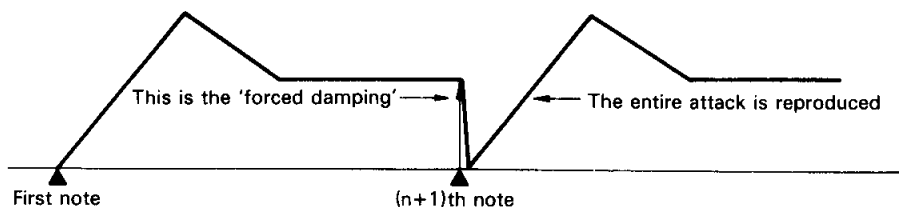

2. *Volume*

(0-99)

The volume of each instrument can be set from 0 to 99. When a performance is first selected, the instruments will be set to the indicated volumes. MIDI Volume control messages (Bn.07.xx) will affect all instruments evenly to preserve the "balance" set here.

3. Output Assign

(off, I, II, I II)

Each instrument can be sent from neither, either, or both of the programmable outputs I and II. No matter what this setting is, the signal from each tone generator is always sent from its own individual audio output --- this cannot be switched off. Even when two or more tone generators are linked (p.) to make a 4-16 note polyphonic instrument, the notes will be spread over the individual outputs. Thus, when using linked tone generators, it is probably easier to use the Assignable Outputs I and II, which assign all the linked tone generators of an instrument together.

The individual outputs are useful when you need independent EQ, panning and effects on each instrument, for example when using the TX802 as a percussion tone generator with the PMC1 Percussion MIDI Controller or the RX Rhythm Programmer.

4. Low/High Limit

(C-2 - G8)

High and Low limits can be set for each instrument. Incoming notes falling outside of these limits will not be played. Using this, you can create split keyboard effects using just one MIDI channel.

Instruments set to Alternate Assign (p.15) will all use the Low/High limits of the left-most instrument.

5. Midi Note Shift

(-24 - +24)

The incoming MIDI Note On message can be transposed up or down for a maximum of two octaves. However, the resulting "note number" cannot fall outside the MIDI note range of 0-127. Midi Note is independent of the voice parameter Transpose (p.19), and the two will be added together to determine the note actually sounded.

6. Micro Tuning Scale/Key Select

(Preset 1-11, Internal 1-2, Cartridge 1-63)

(C-B)

Each instrument can use a different tuning; you can choose from the 11 internal presets, the 2 internal user tunings, or 63 user tunings from a cartridge. Move the cursor to an instrument and use the +1/-1 keys to select a tuning for that instrument. When there is a choice of key (P02 - P05), move the special cursor on the upper line to the key (ENTER + CURSOR) and select using +1/-1. When "Internal" or "Cartridge" is displayed, move the special cursor on the upper line in the same way and select I01/I02 or C02-C63.

P01	Equal temperament	
P02	Pure major	C . . . B
P03	Pure minor	A . . . G#
P04	Mean tone	C . . . B
P05	Pythagorean	C . . . B
P06	Werckmeister	
P07	Kirnberger	
P08	Vallotti & Young	
P09	1/4 shifted equal temperament	
P10	1/4 tone	
P11	1/8 tone	
I	Internal memory	
	I01, I02	
C	Cartridge memory	
	C01 . . . C63	

The "normal" setting is P01 Equal Temperament. If you have selected a cartridge tuning but a cartridge is not inserted P01 will be used.

If you have modified a tuning using SYSTEM 6 > Micro Tune Edit (p.9), the bank name (P, I, C) will be shown in lowercase letters (p, i, c).

For the tuning details of scales P01 to P08 see the data table on p.28. P09 1/4 Shifted Equal Temperament is the normal scale shifted up 50 cents. When P10 1/4 Tone is used, the interval between each key is 50 cents (ie. play 24 keys to move one octave). When P11 1/8 Tone is used, the interval between each key is 25 cents (ie. play 48 keys to move one octave.)

7. Performance Detune

(-7 - +7)

Each instrument can be detuned independently. Two instruments playing the same voice in unison can be detuned to create a rich sound.

8. Performance Name

Each performance memory can be given a 20-character name. Use the ten-key pad to enter the characters printed on them. Each press will step through the four characters printed on each key. UPPERCASE/LOWERCASE selects capital or small letters. (The cursor will point up or down to indicate this.) Pressing ENTER will leave a blank space and move to the right.

VOICE EDIT (I)

In this section we assume you already know something about FM synthesis. If not, turn to p.24 and read "What's FM?" before continuing.

VOICE EDIT (I) is where you edit the parameters that determine how a voice sounds; ie. the FM synthesis parameters. When you press VOICE EDIT (I) you will get the following display. Press the PARAMETER SELECT keys 1-8 to select the parameters displayed in the lower line.

				Voice name					MIDI receive channel
VOICE EDIT(I) MENU <GrandPiano> Rch= 1 opsel alg osc eg level sens lfo peg									
1	2	3	4	5	6	7	8		

The Voice Edit Buffer

When you select a Performance Memory, voice data for each instrument in the performance is loaded into a place called the Voice Edit Buffer, and this data tells the TX802 how to produce sound. There is a separate Voice Edit Buffer for each instrument 1-8. Changes you make in VOICE EDIT mode affect only these buffers, and are not permanent unit Stored into an Internal or Cartridge Voice Memory. (See Store p.7). Once a voice has been edited, the LCD in PERFORMANCE SELECT or VOICE SELECT mode will show the voice bank in lower-case letters (e.g. i64 or a45), indicating that the voice data has been modified.

Compare

Any time you are editing a voice, you can press COMPARE to see and hear the original voice data. In COMPARE mode, the lower line of the LCD will blink, and you will not be able to modify the data. Lock through the parameters just as in normal edit mode. To return to edit mode, press COMPARE again.

1. Operator Select & On/Off

Most of the parameters 2-6 in VOICE EDIT (I) can be set independently for each operator. Step through the operators by pressing PARAMETER SELECT 1. When editing, it is often useful to hear only a certain combination of operators at once. By pressing ENTER + ten-key 1-6, you can turn each operator on or off. The "111111" at the left indicates which operators are on (1) or off (0). If an operator is turned off you will not be able to edit it. Obviously, if all carriers are turned off, there will be no sound.

2. *Algorithm*

These are parameters that affect the entire voice.

Algorithm (1-32)

The Algorithm, or "arrangement" of operators. The pull-out reference card under the LCD has a diagram of the 32 algorithms.

Feedback Level (0-7)

One operator in each algorithm (see the pull-out reference card) can be set to modulate itself on a scale of 0 (no feedback) to 7.

Oscillator Key Sync (on/off)

Turning this on forces the sine waves of all 6 operators to begin from phase 0 when a key is played.

Transpose (C1 - C5)

The voice can be transposed ± 2 octaves from the normal setting of C3. By playing a note while pressing ENTER, you can quickly set the Transpose point.

Voice Name (10 characters)

As described in Performance Name (p.17), use the ten-key pad to enter a voice name.

3. *Oscillator*

The frequency of each operator can be set here. You have the option of two types of display; alternate by pressing PARAMETER SELECT 3. One display shows all frequency settings for a single operator. The other shows coarse and fine for all 6 operators. (Select operators using PARAMETER SELECT 1.)

Mode (ratio/fixed)

In Ratio mode, the frequency of the operator will depend on the key that is played. In Fixed mode, the frequency is displayed in "Hz", and remains the same regardless of the key that is played.

Coarse/Fine Frequency

Move in large steps when the cursor is at "Coarse"; move in small steps when the cursor is at "Fine".

Detune (-7 - +7)

An "extra fine" frequency adjustment over a range of approximately ± 2 cents.

4. *Envelope Generator*

Envelope Generator and Rate Scaling for each operator. You have the option of two types of display; alternate by pressing PARAMETER SELECT 4. One display shows all EG parameters numerically for a single operator. The other is a graphic display of Levels for all 6 operators. (Select operators using PARAMETER SELECT 1.)

The envelopes of several operators will often have similar envelopes. You can save time by using the Copy EG & Scaling utility (p.13).

Rate Scaling (0-7)

When Rate Scaling is 0, the envelope will be the same speed for any note on the keyboard. As Rate Scaling is increased, higher notes will have faster envelopes.

Rate 1-4 (0-99)

Level 1-4 (0-99)

Levels and Rates 1-4 determine the "shape" of the envelope. See the pull-out reference card.

5. Output Level

Operator Output Level and Level Scaling parameters for each operator. You have the option of two types of display; alternate by pressing PARAMETER SELECT 5. One display shows parameters numerically. The other is a full graphic display of levels in groups of 3 keys from A#-1 to C7, corresponding approximately to an 88-key keyboard.

Select Normal or Fractional scaling by moving the cursor to "Mode" in the full graphic display (use ENTER + CURSOR) and using +1/-1. Several operators will often have similar scaling settings. You can save time by using the Copy EG & Scaling utility (p.13).

Normal scaling allows you to adjust operator output level over the keyboard using the following parameters. The pull-out reference card shows how the parameters are related.

Level (0-99)	Operator Output Level
Ld (0-99)	Left Scaling Depth
Lc (+/-, lin/exp)	Left Scaling Curve (linear or exponential)
Bp (A-1-C8)	Break Point
Rc (+/-, lin/exp)	Right Scaling Curve (linear or exponential)
Rd (0-99)	Right Scaling Depth

Fractional scaling allows you to adjust operator output level over a range of 0-255 for each individual group of three keys. You can specify an Offset (Ofst) value over a range of -127 to +127 to shift the overall level setting up or down. The numerical display will also have a partial graphic display as shown below, and the currently selected key group will blink. Move the cursor to select the key group. Or you can jump to any key group by playing a note on a MIDI keyboard while pressing ENTER.

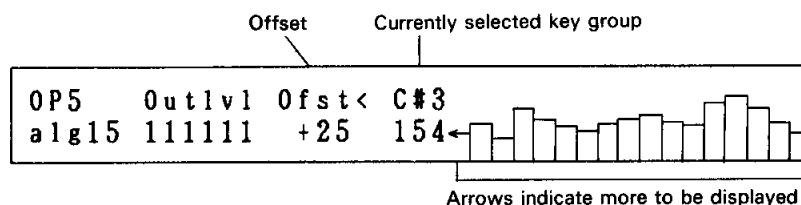

If a voice is created using Fractional Scaling, a cartridge containing Fractional Scaling must be inserted when the voice is used. If not, the "f" in PERFORMANCE SELECT and VOICE SELECT modes will blink.

6. Sensitivity

Velocity and Amplitude Modulation Sensitivity for each operator, and Pitch Modulation Sensitivity (common to all operators). The diagram on p.21 shows how LFO modulation is sent to the operators.

Velocity (0-7) Key Velocity Sensitivity

This sets the effect that Key Velocity will have on operator output level. When set to zero, Key Velocity will have no effect.

Ams (0-7) Amplitude Modulation Sensitivity

This sets the sensitivity of the operator to amplitude modulation coming from the LFO and from EG Bias. At zero the operator will be unaffected.

Pms (0-7) Pitch Modulation Sensitivity

This sets the sensitivity of the entire voice to pitch modulation coming from the LFO. At zero, the voice will have no pitch modulation.

7. LFO

Low Frequency Oscillator parameters (common to all operators). The diagram below shows how LFO modulation is sent; either "automatically" (AMD and PMD) or regulated by a controller (see p.23). As you can see from the diagram, if the Sensitivity settings are 0, the LFO will have no effect.

Wave (triangle, saw down, saw up, square, sine, s/hold)

Five periodic wave-shapes and "random" sample-and-hold.

Speed (0-99)

Adjusts the LFO frequency.

Delay (0-99)

A time delay can be set before the LFO begins.

Mode (single, multi)

In Single mode, the LFO begins when the first key is hit and continues with the same phase for all subsequent notes. (I.e. the LFO effect is "synchronized" for all notes.)

In Multi mode, an independent LFO begins when each note is played. Thus, each note can be at a different phase.

Pmd (0-99) Pitch Modulation Depth

Amd (0-99) Amplitude Modulation Depth

Pitch Modulation Depth and Amplitude Modulation Depth determine the amount of LFO signal sent directly to the voice; i.e. "automatic" as opposed to an effect regulated by a Controller, etc. (p.23).

Sync (off, on) LFO Key Sync

When Sync is on, each note restarts the LFO from phase 0.

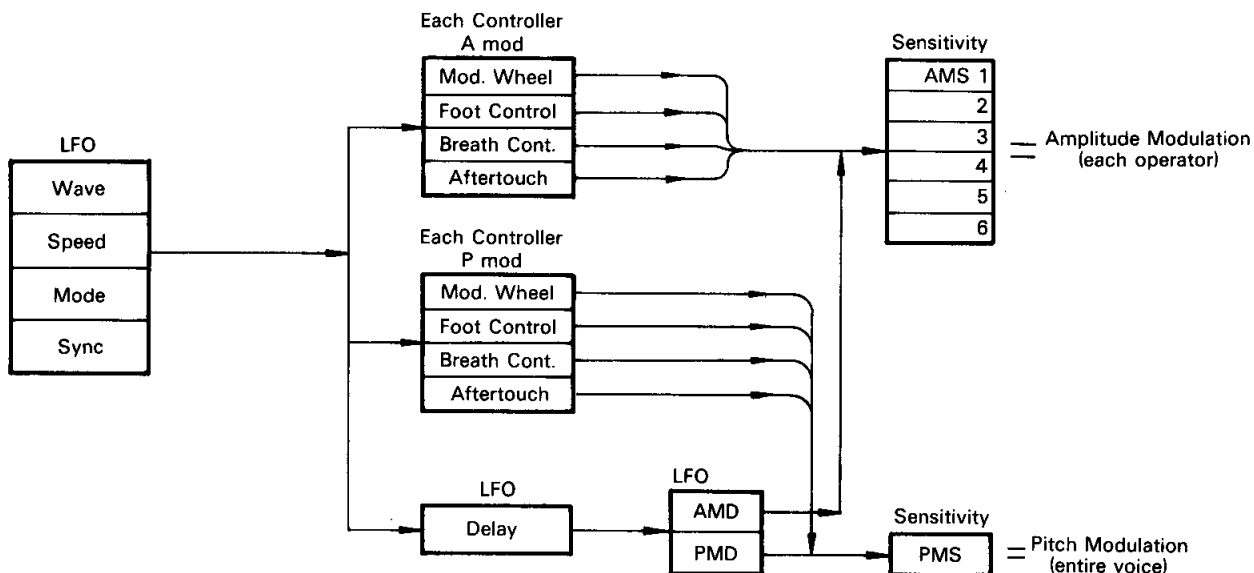

8. Pitch EG

Pitch Envelope Generator rates R1-4 and levels L1-4 determine how the pitch changes with time. Level 50 is the normal pitch. The difference in pitch between levels of 0 and 99 can be set from 1/2 to 8 octaves. When Pitch EG Velocity Sensitivity is switched on, the intensity of the Pitch EG effect will depend on the key touch. When Rate Scaling is 0, the envelope will be the same speed for any note on the keyboard. As Rate Scaling is increased, higher notes will have faster envelopes.

- Rng (1/2, 1, 2, 8 octaves) Range
- Vel (off, on) Pitch EG Velocity Sensitivity
- Rs (0-7) Rate Scaling
- R1-4 (0-99) Rate 1-4
- L1-4 (0-99) Level 1-4

VOICE EDIT (II)

This is where you determine how a voice will be controlled via MIDI. When you press VOICE EDIT (II) you will get the following display. Press the PARAMETER SELECT keys 1-8 to select the parameters displayed in the lower line.

	Voice name		MIDI receive channel				
VOICE EDIT(II) MENU <GrandPiano>			Rch= 1				
mode bend rpch prta wheel foot brth aftr							
1	2	3	4	5	6	7	8

Compare

Any time you are editing a voice, you can press COMPARE to see and hear the original voice data. In COMPARE mode, all parameters in the LCD will blink, and you will not be able to modify the data. Look through the parameters just as in normal edit mode. To return to edit mode, press COMPARE again.

1. Key mode

(poly, mono)

Poly is the normal mode, when a voice will be played with as many simultaneous notes as the performance setting allows (see Linked Tone Generators, p.7).

In Mono mode, only the last note you play will be sounded. Mono mode allows you to use Fingered Portamento (see p.23). When an instrument is Alternately Assigned (p.15), Mono is ignored.

2. Pitch bend

Range (0-12)

Set to 0, the Pitch Bend Wheel will have no effect; set to 12, the maximum bend will be an octave.

Step (0-12)

Set to 0, the pitch bend will be continuous. Set 1-12, the bending effect will be in "steps" of 1-12 semitones. When Step is set to 1-12, Range will automatically be set to 12.

3. Random pitch

Depth (0-7)

When set between 1 and 7, the pitch will be given an increasing randomness, useful for creating a "naturally irregular" feel.

4. Portamento

There are two modes of Portamento (the "glide" between notes), and your choice will differ between Poly and Mono modes (see above). Portamento can be switched on/off via MIDI.

Portamento Mode

When in Poly mode:

Sus. Key Retain: Notes held with the sustain pedal are retained as the pitch glides to the new note.

Sus. Key Follow: Notes held with the sustain pedal glide to the new note.

When in Mono mode:

Fingered: Portamento will occur only when a key is pressed while another key is always present.

Fulltime: Portamento always occurs.

Step (0-12)

The "glide" between notes can be smooth (Step=0) or in steps of up to one octave (Step=12).

Time (0-99)

The time it takes for the pitch to change. Portamento Time of 0 is the same as no effect. 99 gives the slowest portamento.

5. Mod. wheel

Pmod (0-99)

Amod (0-99)

EG bias (0-99)

Volume (0-99)

6. Foot control

You can specify what incoming Modulation Wheel and Foot Control messages will ob. They can regulate the amount of Amplitude Modulation or Pitch Modulation coming from the LFO (see the diagram on p.21). Or they can directly control the output level of operators, i.e. "biasing" the envelope generator. (The operator must be programmed with some Amplitude Modulation Sensitivity, see p.20). Raising each value gives more control. The Foot Controller (not the Modulation wheel) can also regulate volume.

7. Breath control

Pmod (0-99)

Amod (0-99)

EG bias (0-99)

P bias (-50 - +50)

8. After touch

In addition to the three parameters explained above, you can make the Breath Controller or Aftertouch directly affect the pitch by using. Pitch Bias. Positive settings will make the pitch go up and negative settings will make the pitch go down. (Use the "-" key to enter a negative number.)

WHAT'S FM?

A complete discussion of FM synthesis is beyond the scope of this manual. Here we will cover only the basic ideas of FM. For a more detailed study, refer to one of the many guidebooks on the Yamaha DX series and FM synthesis that have been published.

FREQUENCY MODULATION

FM stands for Frequency Modulation. In FM, one waveform modulates another waveform, creating a new, complex waveform, as shown below. So to do FM synthesis, we need two oscillators. The upper one is called the "Modulator" and the lower one (which goes directly to the output of the synthesizer) is called the "Carrier". The complexity or "brightness" of the resulting waveform will depend of the output level of the Modulator.

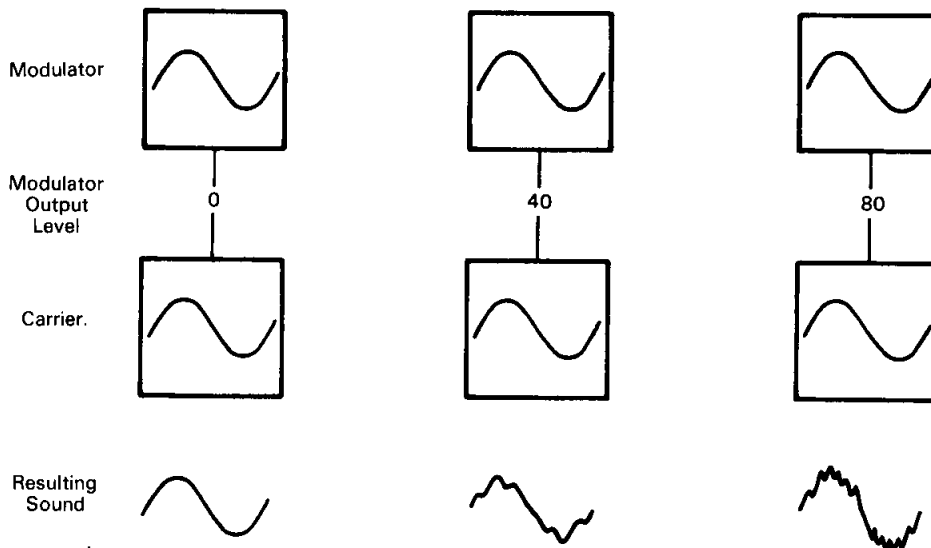

EG (Envelope Generator)

By varying the output level of the modulator, we can produce all kinds of sounds. However, sounds in the real world usually change as time goes by. This "shape in time" is called the Envelope. If the output level of the modulator changes, the tone will change. If the output level of the carrier changes, the volume will change.

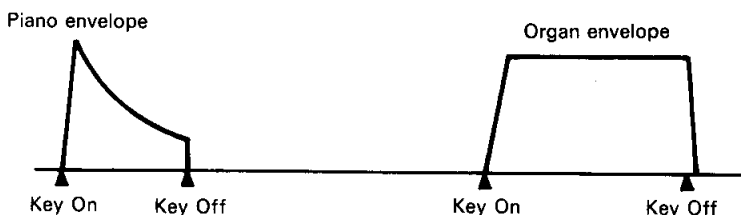

OPERATOR

In Yamaha FM synthesizers, each oscillator has its own Envelope Generator (EG) to vary its output level over time. This "package" is called an Operator. An operator can be either a modulator or carrier. The only difference is how it is used.

ALGORITHM

To do simple FM, you need only two operators, but the TX802 has six, and these six operators can be arranged in 32 different ways. Each arrangement is called an Algorithm. The 32 algorithms are shown on the pull-out operation guide under the LCD display. Algorithm 3 has two carriers, each with two modulators "stacked" on top of it. In algorithm 22, three carriers are modulated by a single modulator, and another carrier has its own modulator. Algorithm 32 has six carriers and no modulators.

FEEDBACK

In the algorithm chart, you will also notice that one of the operators has its output "looped". This means that it can modulate itself; a bit like having an additional operator.

RATIO FREQUENCY

The basic frequency of each operator can be set independently. When an operator is in Ratio mode, it will produce a frequency corresponding to the key that is pressed. If the frequency ratio of the carrier:modulator is 1:1, the resulting sound will contain all the harmonic partials. For example, if the fundamental (the "basic pitch") is 100hz, harmonics of 200hz, 300hz, 400hz ... will be generated. If the frequency ratio is 1:2, the odd-numbered harmonic partials will be generated (100hz, 300hz, 500hz will generate non-harmonic spectra typical of clashing, metallic sounds).

FIXED FREQUENCY

An operator can also be set to Fixed mode, which will cause it to produce the same frequency regardless of what key is pressed. In Fixed mode, the frequency is displayed in Hz (cycles per second) or KHz (1000 cycles per second). If carrier is in Ratio mode and the modulator is in Fixed mode, the harmonic structure of the sound will change depending on the key you press.

LFO

The LFO (Low Frequency Oscillator) produces a slow (i.e. below an audible frequency) vibration that can be used to create vibrato, tremolo or other effects. If the LFO is affecting the output level of a carrier, the result will be Tremolo (periodic change in volume), and if it is affecting the output level of a modulator, the result will be periodic change in tone ("Wah-Wah"). The LFO can also control the pitch of the operators, producing Vibrato (periodic change in pitch).

SENSITIVITY

Acoustic instruments produce different sounds when played softly or loudly. Not only the loudness, but also the tone changes. A softly played note is usually softer in tone as well as volume. FM synthesis provides an easy way to simulate this. Each operator can be "Velocity Sensitive", and adjust its output level according to how hard a key is struck (key velocity). If a carrier is velocity sensitive, the volume will depend on the key velocity. If a modulator is velocity sensitive, the tone will depend on the key velocity.

DETUNE

The harmonic structure of actual acoustic sounds is usually somewhat "irregular". This makes them sound interesting and lifelike. By slightly Detuning each operator, you can create this type of naturally irregular sound.

SCALING

The tonal characteristics of an instrument generally change from note to note. For example, high notes on a piano have a simpler harmonic structure than the bass notes. By Scaling the output level of a modulator to decrease as you play up the keyboard, you can simulate this.

LEARNING FM SYNTHESIS

Creating a voice from the initial setting is not a simple matter. The best way to learn about FM synthesis is to get inside the factory preset voices and see how they work. Turn each operator off one by one, and see how each operator affects the sound. Make small changes in operator output level or EG rates. Try starting from a preset voice that is fairly close to what you have in mind, and edit it to your liking.

SPECIFICATIONS

Dimensions	480 x 287 x 94.5 mm (W x D x H) (2 rack spaces)
Weight	4.9 kg
Power Consumption	15 W
Power Requirements	U.S. and Canadian models: 120 V 50/60 Hz General model: 220 V/240 V 50Hz
Optional Accessories	RAM4 (Data Cartridge) ADP1 (Cartridge Adaptor)

BANK A/B VOICE LIST

BANK A

BANK B

1	MellowHorn	33	Piano 1	1	SuperBass	33	Analog-X
2	SilvaBrass	34	Piano 2	2	StringBass	34	FMilters
3	ReverbBras	35	KnockRoad	3	SkweekBass	35	Phasers
4	Tuba	36	RubbaRoad	4	SmoochBass	36	Ensemble
5	Trombone	37	HardRoads	5	BopBass	37	MalletHorn
6	HardTrumps	38	FullTines	6	OwlBass	38	FM-Growth
7	Trumpet A	39	ClaviStuff	7	JazzBass	39	ElectoComb
8	SilvaTrmpt	40	Clavi	8	HardBass	40	ClariSolo
9	Trumpet B	41	Clavecin	9	GuitarBox	41	PitchaPad
10	FrenchHorn	42	ClaviPluck	10	PickGuitar	42	ClaviBrass
11	Strings	43	NasalClav	11	FingaPicka	43	WhapSynth
12	HallOrch	44	HarpsiBox	12	LeadaPicka	44	Whasers
13	NewOrchest	45	HarpsiWire	13	YesBunk	45	Fifths
14	Analog-Str	46	WireStrg A	14	12 Strings	46	ElecBrass
15	LiveStrg	47	WireStrg B	15	Classipika	47	ElectroBak
16	BowedBass	48	TouchOrgan	16	Shami	48	HarmoSynth
17	EleCello A	49	ShOrgan	17	Maribumba	49	PianoBells
18	EleCello B	50	TapOrgan	18	DX Marimba	50	St.Elmo's
19	Violins	51	BriteOrgan	19	Nu Marimba	51	MilkyWays
20	Bassoon	52	MagicOrgan	20	StonePhone	52	Pluk
21	Clarinet	53	SoftOrgan	21	VibraPhone	53	TingVoice
22	Oboe	54	PipeOrgan	22	Celeste	54	Plukatan
23	Flute	55	PuffOrgan1	23	Swissnare	55	OctiLate
24	SongFlute	56	PuffPipes	24	Tom C4	56	LateDown
25	SpitFlute	57	PuffOrgan2	25	CongaDrum	57	Glastine
26	PanFloot	58	Harmonium1	26	Tub Bells	58	BellWahh
27	Piccolo	59	Harmonium2	27	Gong	59	RubberGong
28	Sax	60	Whisper A	28	Timpani	60	Wallop
29	Harmonica	61	Choir	29	Claves	61	Explosion
30	Harp	62	LadyVox	30	Bells	62	KoikeCycle
31	EbonyIvory	63	MaleChoir	31	SteelCans	63	Thunderon
32	PianoBrite	64	Whisper B	32	Handrum	64	Science

MICRO TUNING DATA TABLE

KEY (CENT)	Equal	Pure C (major)	Pure A (minor)	Mean tone C	Pythago- rean C	Werck- meister	Kirnberger	Vallotti & Young
*C	0	0.000	0.000	0.0000	0.000	0.000	0.000	0.000
*C#	100	70.673	70.673	76.0490	113.685	90.225	90.225	94.135
*D	200	203.910	182.404	193.1569	203.910	192.180	193.157	196.090
*D#	300	315.641	315.641	310.2647	294.135	294.135	294.135	298.045
*E	400	386.314	384.314	386.3137	407.820	390.225	286.314	392.180
*F	500	498.045	498.045	503.4216	498.045	498.045	498.045	501.955
*F#	600	568.718	568.718	579.4706	611.730	588.270	590.224	592.180
*G	700	701.955	701.955	696.5784	701.955	696.090	696.578	698.045
*G#	800	772.628	772.628	772.6274	815.640	792.180	792.180	796.090
*A	900	884.359	884.359	889.7353	905.865	888.270	889.735	894.135
*A#	1000	1017.596	1017.596	1006.8432	996.090	996.090	996.090	1000.000
*B	1100	1088.269	1088.269	1082.8921	1109.775	1092.180	1088.269	1090.225
*C	1200	1200.000	1200.000	1200.0000	1200.000	1200.000	1200.000	1200.000
*C-C#	100	70.673	70.673	76.0490	113.685	90.225	90.225	94.135
*C#-D	100	133.237	111.731	117.1079	90.225	101.955	102.932	101.955
*D-D#	100	111.731	133.237	117.1078	90.225	101.955	100.978	101.955
*D#-E	100	70.673	70.673	76.0490	113.685	96.090	92.179	94.135
*E-F	100	111.731	111.731	117.1079	90.225	107.820	111.731	109.775
*F-F#	100	70.673	70.673	76.0490	113.685	90.225	92.179	90.225
*F#-G	100	133.237	133.237	117.1078	90.225	107.820	106.354	105.865
*G-G#	100	70.673	70.673	76.0490	113.685	96.090	95.602	98.045
*G#-A	100	111.731	111.731	117.1079	90.225	96.090	97.555	98.045
*A-A#	100	133.237	133.237	117.1079	90.225	107.820	106.355	105.865
*A#-B	100	70.673	70.673	76.0489	113.685	96.090	92.179	90.225
*B-C	100	111.731	111.731	117.1079	90.225	107.820	111.731	109.775

This table shows the theoretical values. Actual data in the TX802 is in steps of 1.1719 cents.

TX802 PERFORMANCE MEMORY CHART

Performance No./Name

Instrument	1	2	3	4	5	6	7	8
Voice number								
Channel (alt. assign)								
Forced Damp								
Volume								
Output Assign								
Low/High Limit								
Note Shift								
Micro Tuning Scale								
Micro Tuning Key								
Detune								

Performance No./Name

Instrument	1	2	3	4	5	6	7	8
Voice number								
Channel (alt. assign)								
Forced Damp								
Volume								
Output Assign								
Low/High Limit								
Note Shift								
Micro Tuning Scale								
Micro Tuning Key								
Detune								

Performance No./Name

Instrument	1	2	3	4	5	6	7	8
Voice number								
Channel (alt. assign)								
Forced Damp								
Volume								
Output Assign								
Low/High Limit								
Note Shift								
Micro Tuning Scale								
Micro Tuning Key								
Detune								

Performance No./Name

Instrument	1	2	3	4	5	6	7	8
Voice number								
Channel (alt. assign)								
Forced Damp								
Volume								
Output Assign								
Low/High Limit								
Note Shift								
Micro Tuning Scale								
Micro Tuning Key								
Detune								

VOICE MEMO CHART

Voice Name:

ALGORITHM		OSCILLATOR		OP	1	2	3	4	5	6	Pitch Bend	
ALG		Mode									Range	
FBL		Coarse-Fine									Step	
OSC.Sync		Detune									Portamento	
Transpose		E	G	OP	1	2	3	4	5	6	Mode	
Key Mode		RS									Step	
L	F	O									Time	
Wave		R1									Random pitch	
Speed		R2									Modulation Wheel	
Delay		R3									P. MOD	
Mode		R4									A. MOD	
PMD		L1									EG. Bias	
AMD		L2									Foot Control	
Sync		L3									P. MOD	
		L4									A. MOD	
Pitch	E	G			1	2	3	4	5	6	EG. Bias	
Range		Output Level		OP							Volume	
Velocity		Scaling mode									Breath Control	
RS		Output Level									P. MOD	
R1		LD									A. MOD	
R2		LC									EG Bias	
R3		BP									P. Bias	
R4		RC									After Touch	
L1		RD									P. MOD	
L2		Sensitivity		OP	1	2	3	4	5	6	A. MOD	
L3		Velocity									EG. Bias	
L4		AMS									P. Bias	
		PMS										

Function ...	Transmitted	Recognized	Remarks
Basic Default	: 1 - 16	: 1 - 16	: memorized
Channel Changed	: 1 - 16	: 1 - 16	
Mode Default	: x	: 1, 2, 3, 4	: memorized
Mode Messages	: XXXXXXXXXXXXXXXX	: POLY, MONO(M=1)	
Mode Altered	: XXXXXXXXXXXXXXXX	: x	
Note Number : True voice	: x : XXXXXXXXXXXXXXXX	: 0 - 127 : 0 - 127	
Velocity Note ON	: x	: o v=1-127	
Velocity Note OFF	: x	: x	
After Key's	: x	: x	
Touch Ch's	: x	: o	
Pitch Bender	: x	: o 0-12 semi X2:7 bit resolution	
Control Change	: 1 : x : 2 : x : 4 : x : 5 : x : 7 : : 64 : x : 65 : x	: o : o : o : o : o : o	: X1 : Modulation wheel : X1 : Breath control : X1 : Foot control : X1 : Portamento time : X1 : Volume : X1 : Sustain sw : X1 : Portamento sw
Prog Change : True #	: x : XXXXXXXXXXXXXXXX	: o 0 - 127 : 0 - 127	: if prgram change: : X3 : sw is on.
System Exclusive	: o X4	: o X4	
System : Song Pos	: x	: x	
System : Song Sel	: x	: x	
Common : Tune	: x	: x	
System : Clock	: x	: x	
Real Time : Commands	: x	: x	
Aux : Local ON/OFF	: x	: x	
Aux : All Notes OFF	: x	: o (126,127)	
Mes- : Active Sense	: x	: o	
sages:Reset	: x	: x	
Notes:	X1 = receive if control change switch is on.		
	X2 = receive if pitch bend switch is on.		
	X3 = I1-64 (0-63) , C1-64 (64-127) for Performance.		
	I1-64 , C1-64 , A1-64 , B1-64 (0-63) for Voice.		
	X4 = Bulk dump & param. change of Voice,Perf,System,mtune,frac.:		
Mode 1 : OMNI ON, POLY	Mode 2 : OMNI ON, MONO	o : Yes	
Mode 3 : OMNI OFF, POLY	Mode 4 : OMNI OFF, MONO	x : No	

MIDI RECEPTION

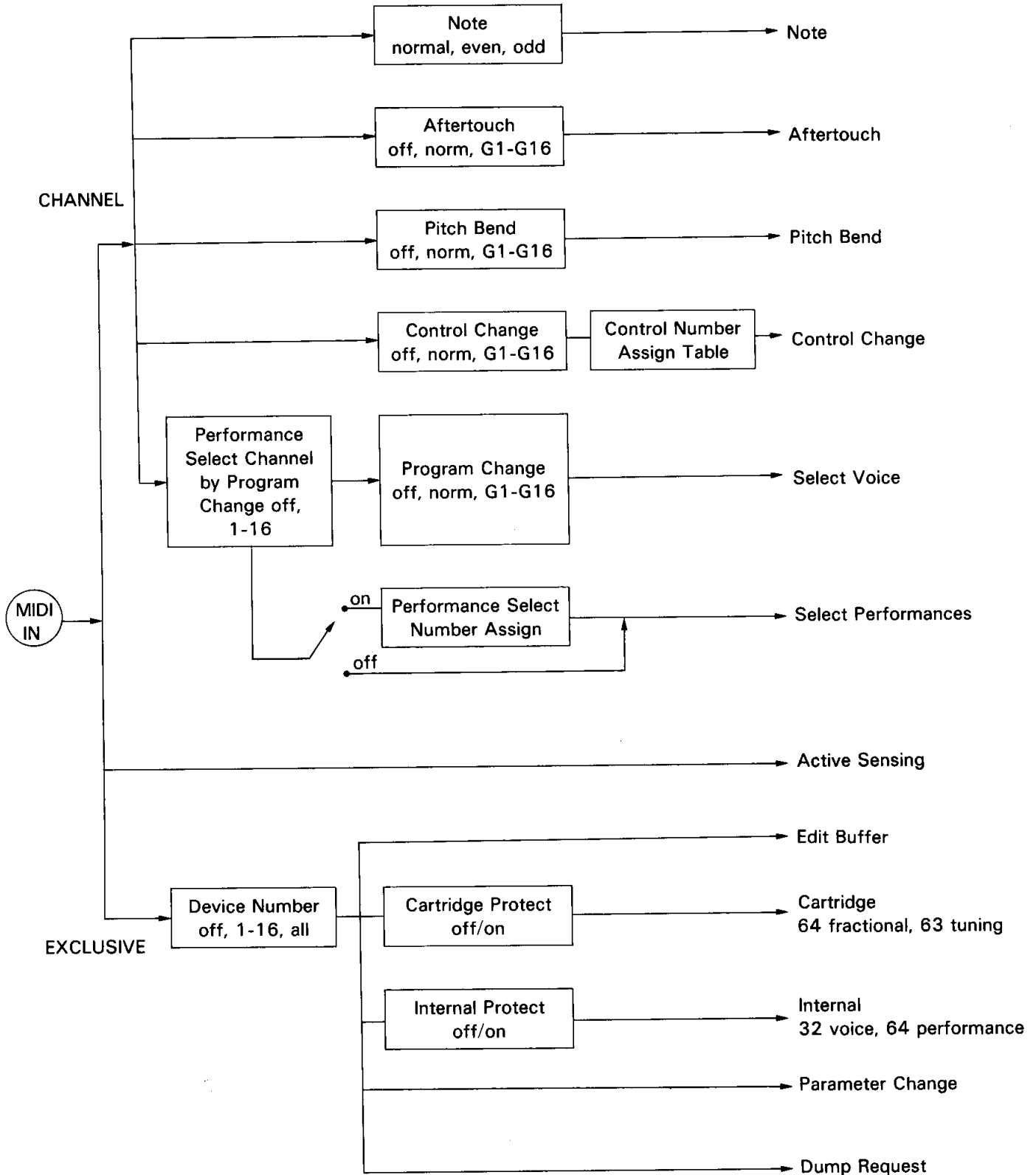

MIDI TRANSMISSION

Using UTILITY 1 you can transmit various types of System Exclusive bulk data from the TX802 to another TX802 or to a MIDI bulk data storage device such as the MDF1 or the floppy disk drive in the DX7IIFD. (Details of the System Exclusive data format may be of interest to programmers writing voicing software for the TX802, and will be provided on request.) For your reference, here are the sizes of the bulk data.

32 Voice (VMEM + AMEM)	4104 + 1128 bytes (transmitted as 2 messages)
64 Performance (PMEM)	11598 bytes
System Setup	281 bytes
Micro Tuning (1 Internal)	274 bytes
Micro Tuning (63 Cartridge)	16952 bytes
Fractional Scaling Cartridge	16165 bytes

This data will be received as shown in the MIDI Reception diagram.

MEMORY STRUCTURE

SYSTEM SETUP MEMORY

Changes you make in SYSTEM SETUP (except "Micro Tuning") are preserved until you change them again; i.e. they have no "edit buffer". (If you want to keep the Micro Tuning data that you edited, you must Save it into Micro Tuning memory INT 1-2 or CRT 1-63).

MIDI Message Receive Control Change	(SYSTEM 1)
MIDI Message Receive Program Change	(SYSTEM 1)
MIDI Message Receive After touch	(SYSTEM 1)
MIDI Message Receive Pitch bend	(SYSTEM 1)
MIDI Message Receive Note on/off	(SYSTEM 1)
Control Number Assign Table	(SYSTEM 2)
Performance Select Channel	(SYSTEM 3)
Performance Select Assign Table	(SYSTEM 3)
Device Number	(SYSTEM 4)
Voice Data Receive 1-32/33-64	
Cartridge Bank Select [TX802]	(SYSTEM 5)
Cartridge Bank Select [Fractional Scaling]	
Cartridge Bank Select [Micro Tuning]	
2 Internal Micro Tunings (INT 1, 2)	(SYSTEM 6)
Internal Memory Protect	(SYSTEM 8)

EDIT BUFFERS

Changes you make in other data (Voice, Performance, Micro Tuning) affect only the respective edit buffer, and are not permanent until stored. When you select a Voice, Performance or Micro Tuning, the new data is called into the edit buffer, and the previously edited data is lost. (However you can recall the Voice or Performance edit buffers using UTILITY 7 "Recall".)

The TX802 has 10 edit buffers as follows;

- Voice 1-8
 (each voice 1-8 has its own Edit Buffer with Fractional Scaling)
- Performance
- Micro Tuning
 (this holds the data you edit in SYSTEM 6)

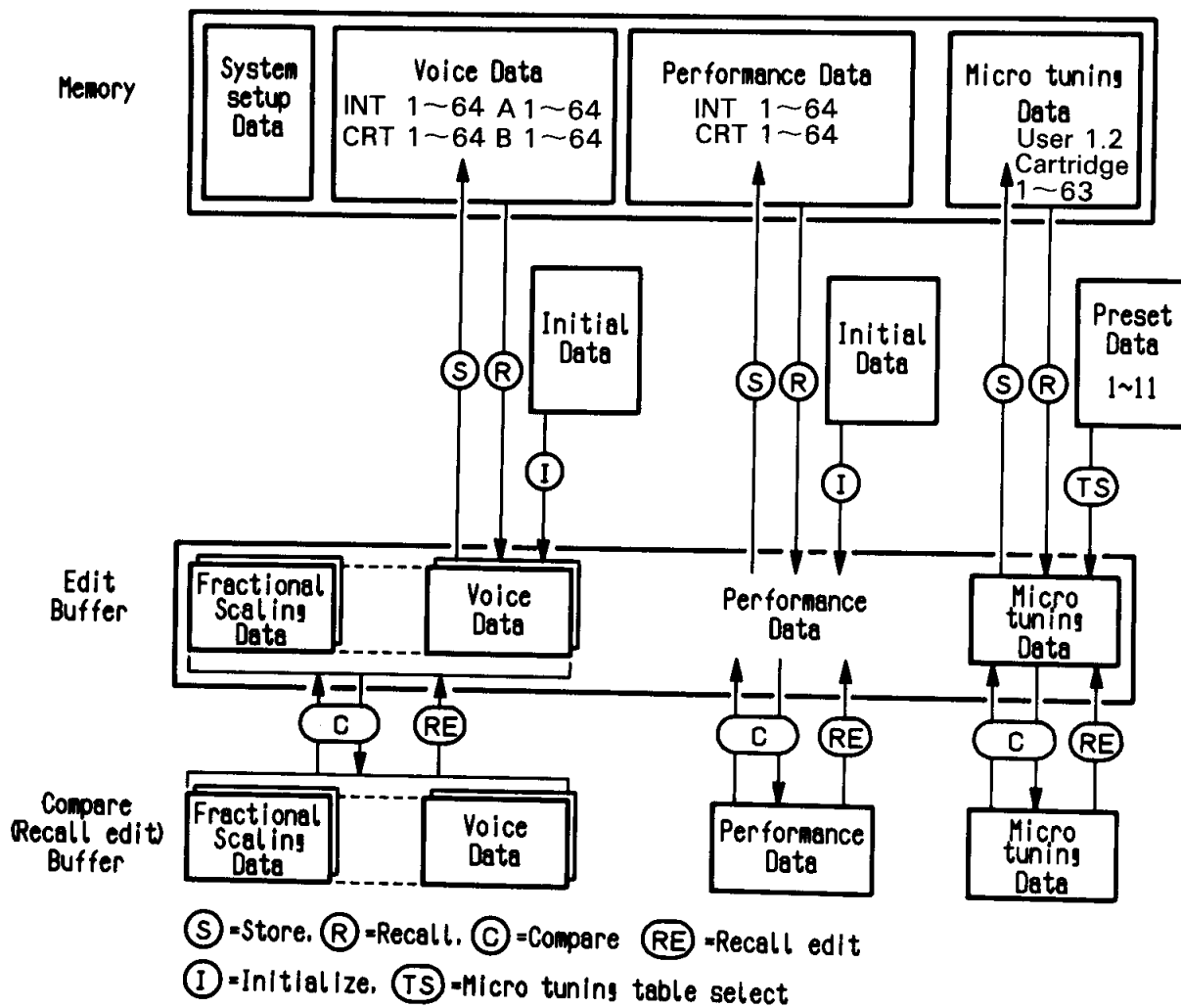

INDEX

Aftertouch	23	Modulation Wheel	23
Algorithm	19	Name (performance)	17
Alternate Assign	15	Name (voice)	19
AMD	21	Note Shift	16
Amod (controller)	23	Operator Select	18
Amplitude Modulation Sensitivity	20	Operator on/off	18
Breath Control	23	Oscillator	19
Cartridge	12	Oscillator Key Sync	19
Cartridge Bank Select	9	Output Assign	16
Compare (performance)	14	Output Level (operator)	20
Compare (voice)	18, 22	Performance Detune	17
Control Number Table	8	Performance Edit	14
Copy (operator data)	13	Performance Edit Buffer	14
Delay (LFO)	21	Performance Name	17
Detune (oscillator)	19	Performance Select	6, 9
Detune (performance)	17	Pitch Bend	22
Device Number	9	Pitch Bias	23
Edit Buffer (initialize)	13	Pitch EG	21
Edit Buffer (performance)	14	Pitch Modulation Sensitivity	2
Edit Buffer (voice)	18	PMD	21
EG	19	Pmod (controller)	23
EG Bias (controller)	23	Portamento	22
EG Forced Damp	15	Random Pitch	22
Envelope Generator	19	Rate (EG)	19
Feedback	19	Rate Scaling	19
Foot Control	23	Recall Edit Buffer	13
Forced Damp	15	Receive (MIDI)	8
Format Cartridge	12	Receive Channel	15
Fractional Scaling	20	Save to Cartridge	12
Frequency (oscillator)	19	Scaling	20
High Limit	16	Sensitivity	20
Initialize Edit Buffer	13	Speed (LFO)	21
Initialize Table	13	Store Performance	6
Key Mode	22	Store Voice	7
Key Sync	19	Sync (LFO)	21
Key Velocity Sensitivity	20	System Exclusive	9
Level (EG)	19	System Setup	8
Level Scaling	20	Tone generator on/off	6, 7
LFO	21	Transmit (bulk data)	11
Limit	16	Transpose	19
Linked Tone Generators	7, 14	Tuning (master)	10
Load from Cartridge	12	Utility Mode	11
Low Frequency Oscillator	21	Velocity Sensitivity	20
Low Limit	16	Voice Edit (I)	18
Master Tuning	10	Voice Edit (II)	22
Memory Protect	10	Voice Edit Buffer	18
Micro Tuning	16	Voice Name	19
Micro Tuning Edit	9	Voice Select	7
MIDI Receive	8	Volume (controller)	23
Mode (LFO)	21	Volume	15
Mode (oscillator)	19	Wave (LFO)	21

FCC INFORMATION

While the following statements are provided to comply with FCC Regulations in the United States, the corrective measures listed below are applicable worldwide.

This series of Yamaha professional music equipment uses frequencies that appear in the radio frequency range and if installed in the immediate proximity of some types of audio or video devices (within three meters), interference may occur. This series of Yamaha professional music equipment has been type tested and found to comply with the specifications set for a class B computing device in accordance with those specifications listed in subpart J of part 15 of the FCC rules. These rules are designed to provide a reasonable measure of protection against such interference. However, this does not guarantee that interference will not occur. If your professional music equipment should be suspected of causing interference with other electronic devices, verification can be made by turning your professional music equipment off and on. If the interference continues when your equipment is off, the equipment is not the source of interference. If your equipment does appear to be the source of the interference, you should try to correct the situation by using one or more of the following measures:

Relocate either the equipment or the electronic device that is being affected by the interference. Utilize power outlets for the professional music equipment and the device being affected that are on different branch (circuit breaker or fuse) circuits, or install AC line filters.

In the case of radio or TV interference, relocate the antenna or, if the antenna lead-in is 300 ohm ribbon lead, change the lead-in to co-axial type cable.

If these corrective measures do not produce satisfactory results, please contact your authorized Yamaha professional products dealer for suggestions and/or corrective measures.

If you cannot locate a franchised Yamaha professional products dealer in your general area contact the professional products Service Department, Yamaha Music Corporation, 6600 Orangethorpe Ave., Buena Park, CA 90620, U.S.A.

If for any reason, you should need additional information relating to radio or TV interference, you may find a booklet prepared by the Federal Communications Commission helpful: "How to Identify and Resolve Radio-TV Interference Problems". This booklet is available from the U.S. Government Printing Office, Washington D.C. 20402 - Stock No. 004-000-00345-4.

YAMAHA

YAMAHA CORPORATION
P.O.Box 1, Hamamatsu, Japan

VD72840

8804 R2 ① Printed in Japan